

vetscan HUB
User's Manual





🏠 Zoetis Services LLC, 333 Portage Street, Kalamazoo, MI 49007 USA | +1 973 822 7000 | www.zoetis.com

🌐 Zoetis Belgium SA, Rue Laid Burniat 1, 1348 Louvain-la-Neuve, Belgium

For veterinary use only   **RoHS**

All trademarks are the property of Zoetis Services LLC or a related company or a licensor unless otherwise noted.
© 2023 Zoetis Services LLC. All rights reserved.

Table of Contents

Disclaimer	4
Intended Use	4
System Overview	5
Powering On/Powering Off	6
Touch Screen	6
Setting up the Vetscan Hub	7
Maintenance	8
Cleaning the Display	8
Cleaning the Stand	8
Appendix A: Troubleshooting	9
Zoetis Resources	9
Appendix B: Specifications	10
Appendix C: Symbols	11
Appendix D: Safety and Regulatory Compliance	12
Safety Warning Labels	12
Safety Compliance	12
Electromagnetic Compatibility (EMC)	12
Declaration of Conformity	12
US FCC	12
CANADA IC WARNING	12

Disclaimer

No part of this publication may be reproduced or transmitted in any form or by any means, electronic or mechanical, including photocopy, recording, or any information storage or retrieval system, without permission in writing from Zoetis.

Zoetis reserves the right to modify its products and services at any time. This user's manual is subject to change without notice. Although prepared to ensure accuracy, Zoetis assumes no liability for errors, or for any damages resulting from the application or use of this information. No rights are granted for diagnostic uses. No rights are granted for use of the product for commercial application of any kind, including but not limited to manufacturing, quality control, or commercial services, such as contract services or fee for services. It is the responsibility of the purchaser/end user to acquire any additional intellectual property rights that may be required.

For user safety and to avoid injury or damage, please read and follow all instructions, warnings, cautions, and notes marked in this manual and on the associated device before handling/operating the device. If the Vetscan Hub is used in any other way than described in this manual, there is a risk of injury or damage to the device.

Intended Use

The Vetscan Hub is a touch screen user interface for Vetscan diagnostic systems, allowing customers to manage their diagnostic worklist and connect to compatible practice information management software (PIMS). The Vetscan Hub is intended for veterinary use only.

System Overview

The Vetscan Hub connects to Vetscan diagnostic analysers, enabling practitioners to simplify clinical workflow through:

- Complete instrument controller for all Zoetis screenless analysers
- Worklist management
- Running and executing diagnostics tests on Vetscan analysers
- Patient-centric test visualisation
- Bi-directional practice information management software (PIMS) connectivity linking patients and test results for simple billing and medical record management
- Over-the-Air (OTA) analyser software updates

The Vetscan Hub is comprised of a single touch screen user interface, power adapter, country specific power cord, Ethernet cable, and quick start guide.

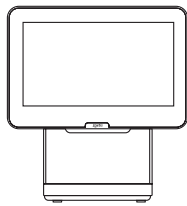

User interface

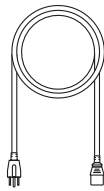

Power cord

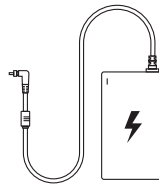

Power adapter

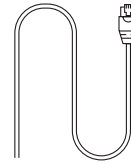

Ethernet cable

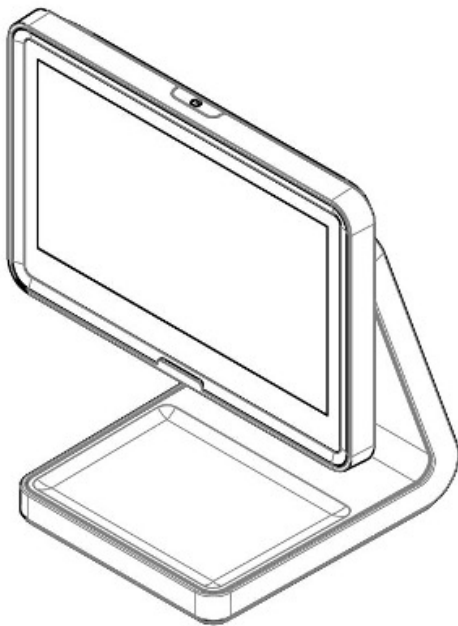

Front View

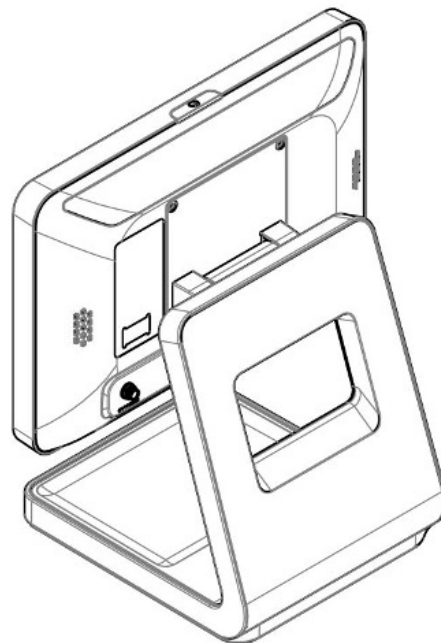

Back View

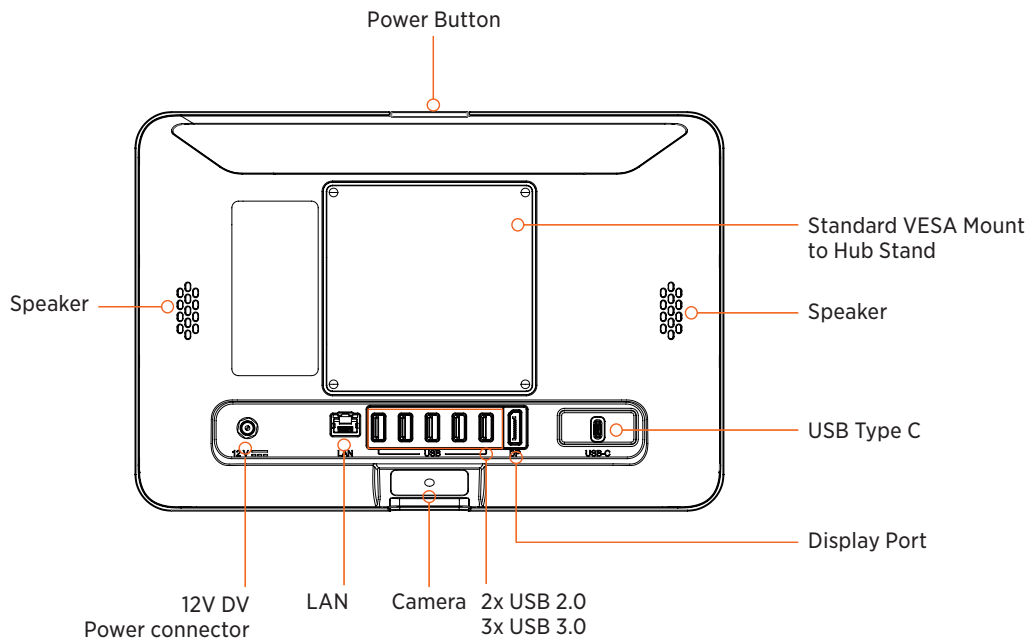

Powering On/Powering Off

The Vetscan Hub can be powered on by pressing the power button on the top of the Vetscan Hub. The screen will then illuminate.

The Vetscan Hub can be powered off by pressing the power button on the top of the Vetscan Hub and holding it for 5 seconds.

The Vetscan Hub is designed to be left on at all times, except when it will not be used for long periods (i.e., troubleshooting or repair).

If the device will not be used for long periods of time, turn off and unplug from its power source.

Touch Screen

The operator interacts with the Vetscan Hub through a touch screen. Ensure that the protective film is removed from the touch screen prior to use.

Setting up the Vetscan Hub

Step 1: Unpack the contents of the box and place the Vetscan Hub on a stable, level surface.

Step 2: Plug the power cord into the power adapter. Insert the connector of the power adapter cord on the back of the Vetscan Hub and gently screw in until tight. Plug the other end of the power cord into a grounded electric outlet.

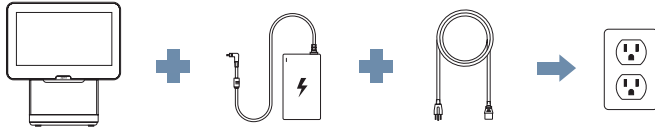

Note: To prevent power surges, do not plug the Vetscan Hub into the same circuit as a centrifuge or any other high-current device.



IMPORTANT: Use the Vetscan Hub only with the original Vetscan Hub power adapter.

Step 3: Connect one end of the Ethernet cable to the Ethernet port on the back of the Vetscan Hub and then connect the other end to the Vetscan Ecosystem Router or clinic network.

Step 4: Press the power button  on the top of the Vetscan Hub. The screen will illuminate. Remove the protective film covering the touch screen and camera located under the bottom of the screen.

Step 5: Follow the on-screen prompts to finish setting up the Vetscan Hub.

To avoid electrical shock and/or damage to the Vetscan Hub, keep the device away from water or liquid sources, keep the device away from high heat or humidity, and keep the device properly ventilated by not blocking or covering the ventilation openings.

Always install and operate the Vetscan Hub near an easily accessible grounded electrical outlet. The Vetscan Hub is powered by an external power supply. Secure the power cord and do not place any object on/over the power cord.

Only install/attach and operate the device on a stable surface and/or recommended mounting.

Maintenance

The Vetscan Hub requires minimal maintenance. Clean the exterior of the Vetscan Hub weekly following the directions below. Regular cleaning of the Vetscan Hub will ensure reliable operation.

Observe universal precautions* when cleaning spills on the Vetscan Hub. Use a 10% bleach solution (1 part bleach to 9 parts water) to clean spills on the stand, following the standard cleaning guidelines in the Cleaning Section.

CAUTION: Zoetis recommends only the cleaning methods described in this section. If for some reason another method is needed, contact Zoetis Technical Service beforehand to verify that the proposed method will not damage the Vetscan Hub. Zoetis is not responsible for damage caused by non-recommended cleaning methods.

Cleaning the Display

Clean the Vetscan Hub screen periodically using a soft, lint-free cloth dampened with a glass-cleaning fluid or window cleaner. **CAUTION:** Do not use any cleaner containing alcohol. Do not spray cleaner directly onto the display — dampen the cloth instead.

Cleaning the Stand

Clean the Vetscan Hub stand with a soft cloth, dampened with a mild, non-abrasive detergent or cleaning solution, such as a 10% bleach solution, or a 30% isopropyl alcohol solution. Pre-soaked towelettes (isopropyl alcohol) may be used as an alternate. Purchase isopropyl towelettes from computer retailers. Do not spray or pour any detergents, solutions, or other liquids directly onto the Vetscan Hub. Dampen a soft cloth or disposable paper towel with the detergent, then apply to the Vetscan Hub stand.

* Follow local guidance and regulations concerning occupational and environmental health and safety

Appendix A: Troubleshooting

The Vetscan Hub is not intended to be serviced by operators. Any Vetscan Hub that requires servicing needs to be returned to Zoetis for repair or replacement. Do not open the Vetscan Hub as opening may create a hazardous situation for you and will void the warranty. This device must be serviced by authorised technicians when:

- Liquid has entered the device interior
- The device has been exposed to high humidity and/or moisture
- The device has been dropped and/or damaged and/or shows obvious signs of breakage
- The device is not functioning or does not function according to the User's Manual

Contact Zoetis Support if you suspect a problem inside the device.

Zoetis Resources

Zoetis provides many resources for animal health laboratories and hospitals. The Zoetis website (www.zoetis.com) contains useful information for the Vetscan Hub and other Zoetis products. It also contains links to technical notes, manuals, product information, and technical support information as well as technical resources on a variety of applications.

Resource	How to Contact
Local Authorised Zoetis Distributor	Find local authorised Zoetis distributors on the Zoetis website (www.zoetis.com).
Technical Information	Find technical information, package inserts, and manuals in the Reference Centre on the Zoetis website (www.zoetis.co).
Technical Support	For technical support assistance, contact your local support service.

Appendix B: Specifications

Dimensions

- Weight: 7 kg (15.5 lbs) (without power supply and LAN cable)
- 11.6" TFT LCD
- Dimensions mm: 307 (W) x 332 (H) x 216 (D), in: 12 (W) x 13 (H) x 8.5 (D)

Power Supply

- AC 100 V–240 V
- Frequency: 50–60 Hz
- Rated Power: 1.8 A

Main Device

- 12 V DC, 5 A, 60 W

Operational Requirements

- Ambient Temperature: 15–40 °C (59–104 °F)
- Relative Humidity: 10–90%, non-condensing
- Altitude: below 2200 meters

Transport and Storage Requirements

- Temperature: 0–50°C (32–122°F)
- Relative Humidity: 8–80%, non-condensing

Location

- For indoor use only













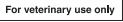

Pollution

- Degree 2

Ingress Protection

- IP20

Appendix C: Symbols

Symbol	Name / Description
	Manufacturer of the device
	Catalogue number
	Model Number
	Consult instructions for use or consult electronic instructions for use
	Electronic manual <i>Indicates the location at which the electronic manual may be retrieved</i>
	Direct current
	For veterinary use only
	Date of manufacturing at production site in Taiwan
	Serial number
	Caution
	Indoor use
	Importer <i>Indicates the identity and address of the importer</i>
	WEEE <i>Indicates that separate collection for waste of electric and electronic equipment (WEEE) is required</i>
	CE Mark European Conformity

Appendix D: Safety and Regulatory Compliance

Safety Warning Labels

Warning labels posted on the Vetscan Hub and in this manual warn you about potential sources of injury or harm. Refer to Appendix C: Symbols to review the meaning of each safety warning label.

Use only the provided power supply and cable when connecting the Vetscan Hub.

NOTE: If the equipment is used in a manner not specified by the manufacturer, the protection provided by the equipment may be impaired. The Vetscan Hub shall be used for the intended use only.

The Vetscan Hub has been tested and is in compliance with all applicable requirements of the following safety and electromagnetic standards:

Safety Compliance

- IEC/EN 61010-1:2010+A1:2016/2019 (Third Edition)
- IEC/EN 62368-1:2014/2014+A11:2017; IEC/EN 62368-1:2018/2020+A11:2020

Electromagnetic Compatibility (EMC)

- IEC/EN 61326-1:2020/2021 Electromagnetic compatibility for measurement, control and laboratory equipment

Declaration of Conformity

This device is in compliance with the EU directives 2011/65/EU (RoHS2) including amendments, 2014/30/EU (EMC), and 2014/35/EU (Low Voltage). The current version of the Declaration of Conformity can be retrieved within the Vetscan Hub application under Settings.

US FCC

This equipment has been tested and found to comply with the limits for a Class B digital device, pursuant to part 15 of the FCC Rules. These limits are designed to provide reasonable protection against harmful interference in a residential installation. This equipment generates, uses and can radiate radio frequency energy and, if not installed and used in accordance with the instructions, may cause harmful interference to radio communications. However, there is no guarantee that interference will not occur in a particular installation. If this equipment does cause harmful interference to radio or television reception, which can be determined by turning the equipment off and on, the user is encouraged to try to correct the interference by one or more of the following measures:

- Reorient or relocate the receiving antenna.
- Increase the separation between the equipment and receiver.
- Connect the equipment into an outlet on a circuit different from that to which the receiver is connected.
- Consult the dealer or an experienced radio/TV technician for help.

CANADA IC WARNING

This device complies with Industry Canada licence-exempt RSS standard(s). Operation is subject to the following two conditions: (1) this device may not cause interference, and (2) this device must accept any interference, including interference that may cause undesired operation of the device.

CANADA IC ATTENTION

Cet appareil est conforme aux normes RSS exempts de licence d'Industrie Canada. Son fonctionnement est soumis aux deux conditions suivantes: (1) cet appareil ne doit pas causer d'interférences et (2) cet appareil doit accepter toute interférence, y compris les interférences pouvant provoquer un fonctionnement indésirable de l'appareil.



Zoetis Services LLC
333 Portage Street
Kalamazoo, MI 49007, USA
www.zoetis.com

Zoetis Belgium S.A.
Rue Laid Burniat 1,
1348 Louvain-La-Neuve, Belgium